

iQPUMP[®]

The Intelligent Pump Controller



HP Range
5 - 150 HP @ 208/230 VAC
5 - 500 HP @ 480 VAC

Typical Applications:

Commercial and Residential Irrigation | Fluid Storage Tanks

Settling Ponds | Sewage Lift Stations

Booster Pump Stations (Municipal, High-rises, Condos, Apartment Complexes, Residential Developments)

iQpump is UL approved for single-phase and three-phase AC input voltage

Manufactured by
YASKAWA
The Drive for Quality™

iQpump Concept

The iQpump controller was designed with the pump service operators and pump system owners in mind. iQpump offers ease of setup and comprehensive pump and motor protection features. The integrated pump specific software and set up parameters, allow the operator to program control values for a wide range of applications. The iQpump controller will automatically adjust pump operating conditions, as the process variables change while still maintaining optimum pump performance and protection. iQpump can also replace phase converters when converting from a single-phase to a three-phase pump motor.

Simplex System Overview

Easy Installation and Set up

1. Wire iQpump Controller
2. Connect pipe to pump
3. Set Pressure (PSI) Reference
4. Calibrate Feedback Level (PSI)
5. Start iQpump controller

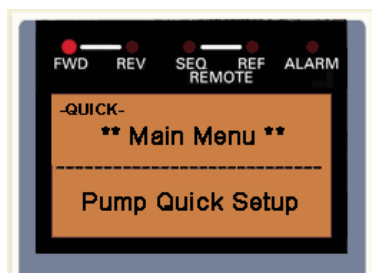
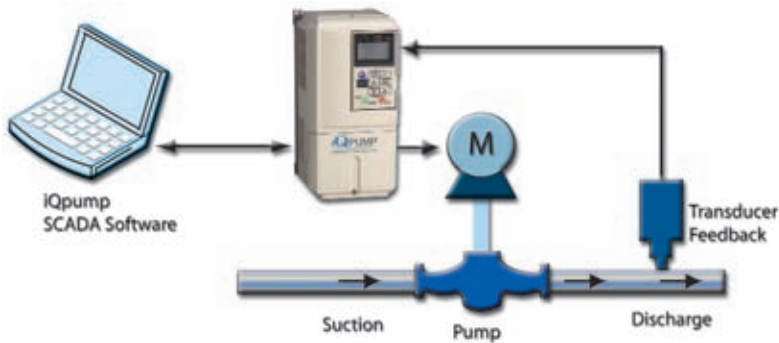

iQpump has an on-board "Pump Quick Setup" menu and with just a few simple answered questions a Simplex system can be running in minutes.

Typical Pump Energy Consumption and Savings

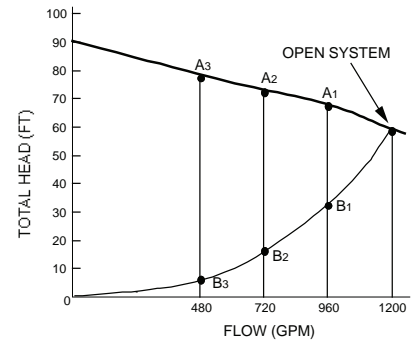

Comparison of Operating Points for Throttling (A) and Adjustable Speed (B) Flow Control

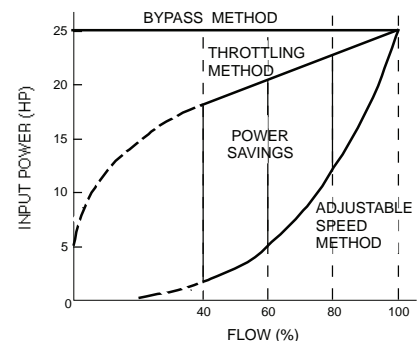

Above chart graphically shows the power requirements and savings for the various flow rates, comparing both throttling and bypass methods to adjustable speed method.

Multiplex Pump System Overview

iQpump has enhanced software over typical variable frequency drives allowing for multiple drives to communicate in a coordinated effort allowing pump system engineers the ability to add more modular pump systems together (Duplex, Triplex, etc.) to meet customer specifications.

- iQpump can support up to 8 pumps on internal Modbus RS485 communication
- Automatically starts and stops Lead and Lag pumps on system demand
- Automatically alternate all pumps with a system programmable timer to provide even mechanical pump wear
- Programmable Priority Run and Alternate Sequence for custom pump systems
- Configurable transducer feedback settings to provide redundant backup if failure occurs
- No PLCs or control relays are required, therefore reducing total system cost and improved reliability

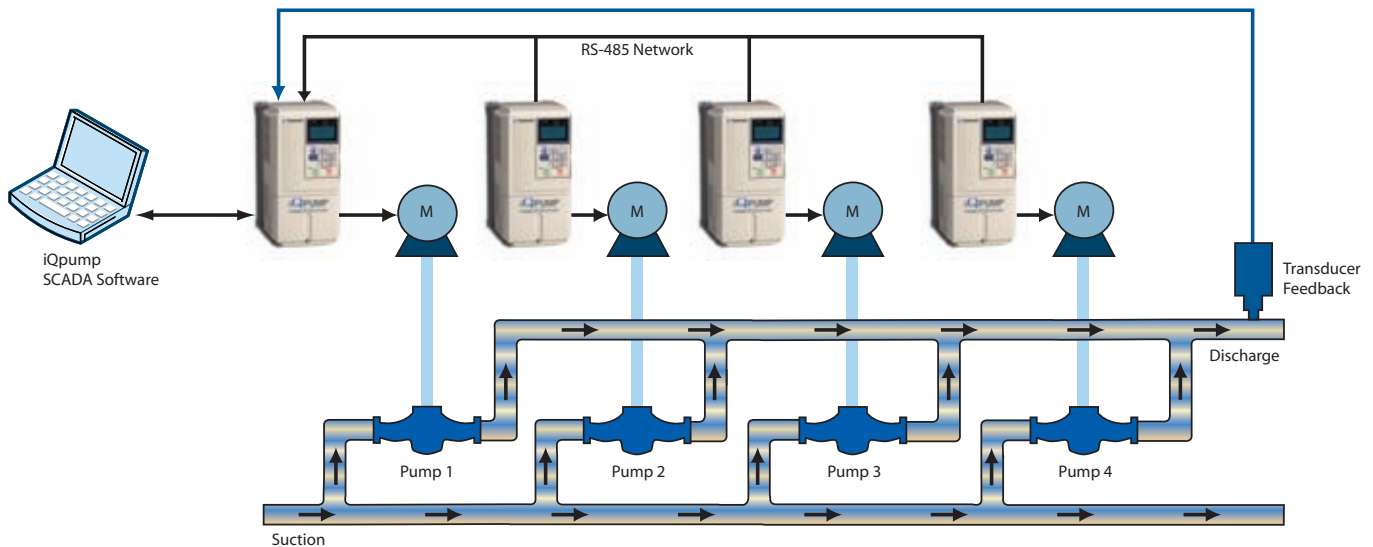

Typical Multiplex Keypad Messages

The iQpump Keypad will provide the user with all the necessary system status operation and pump fault messages to ensure that service operators can efficiently monitor and diagnose any condition.

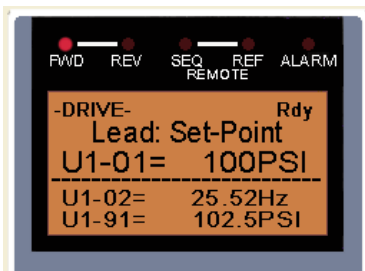

iQpump is in Auto Mode and is the Lead pump.

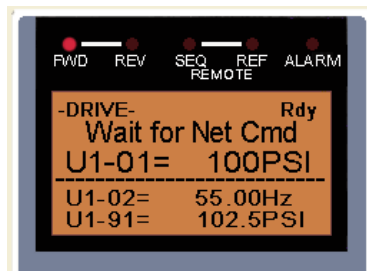

iQpump is in Auto Mode and waiting for a run command from the network based on system pressure.

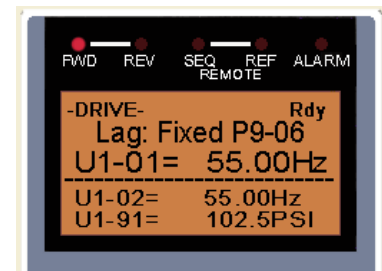

iQpump is in Auto Mode and when Lag operation is called for, iQpump is switched from lead (PI Control) to lag fixed speed control.

Benefits

iQpump can be used to replace existing mechanical pump systems using Throttling Valves, Bypass Valves or other means of flow control to improve regulation and save energy. iQpump was designed to control typical pumping applications that require systems to regulate Constant Pressure, Constant Flow, or Variable Flow/Pressure.

Improved Process Control

By matching pump output flow or pressure directly to the process requirements, small variations in the process can be corrected more rapidly by iQpump than by other control forms.

Improved System Reliability

Any reduction in speed achieved by using iQpump has major benefits in reducing pump wear, particularly in bearings and seals.

Reduce Total System Cost

iQpump lowers system cost by eliminating sensors, jockey pumps, restriction valves as well as reducing cable and tank sizing.

Energy Savings

Depending on application, iQpump will reduce the demand for energy by 20 to 50% by adjusting pump speed to match a lower flow/pressure.

Ease of Installation and Set Up

iQpump uses pump terminology on all setup parameters and monitors. Also included is a "Pump Quick Setup" menu.

Eliminate Complex Control Panels

By installing iQpump, many of the electromechanical controls can be eliminated. This will reduce the maintenance that these panels require.

Reduce Mechanical Stress and Damage to Pumps

iQpump has soft-start and soft-stop capabilities. Pressure surges and water hammer are eliminated.

Cooler Running Pump Motor

Soft start eliminates inrush current, dramatically increasing winding insulation life.

Pump Specific Operator Keypad

Onboard LCD English display reduces field start up and troubleshooting time, with intuitive pump related terminology. Programmable pump process set points are adjusted using "True Engineering Units" (PSI, GPM, Flow, etc.). iQpump provides real time alarms, status and operating conditions in an easy-to-read format.

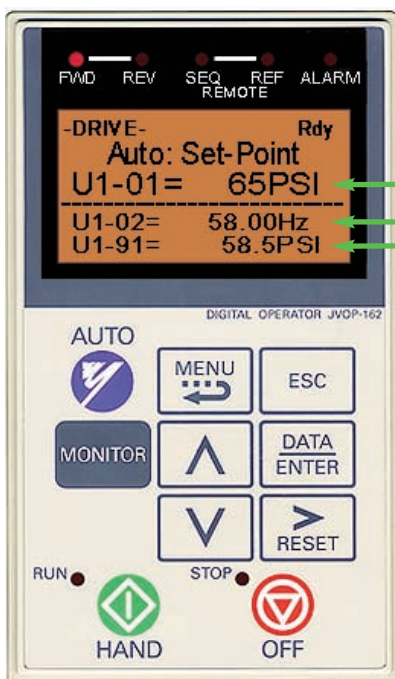

Pressure Setpoint
Pump Motor Frequency
Transducer Feedback

Hand-Off-Auto

Selectable by digital input or controller keypad.

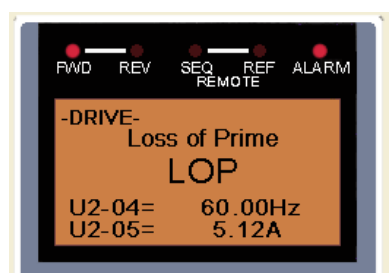
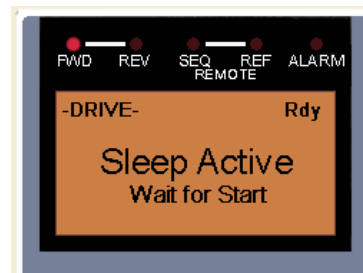
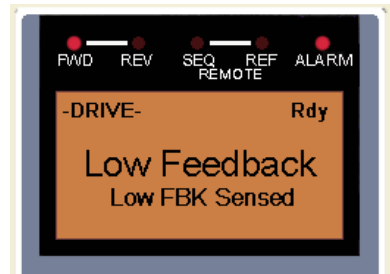
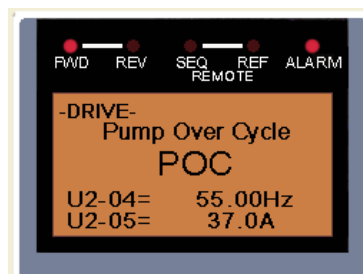

Typical Operator Keypad Messages

iQpump Software Suite

The iQpump Software Suite is included with each iQpump Intelligent Pump Controller:

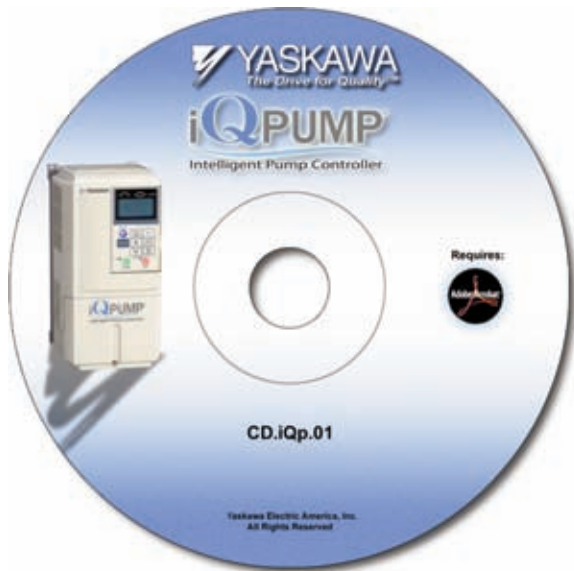

PC SCADA

Troubleshooting, Monitoring, Startup Wizard, Programming, and Trending



Energy Savings Predictor

Analysis of energy savings with carbon footprint calculation

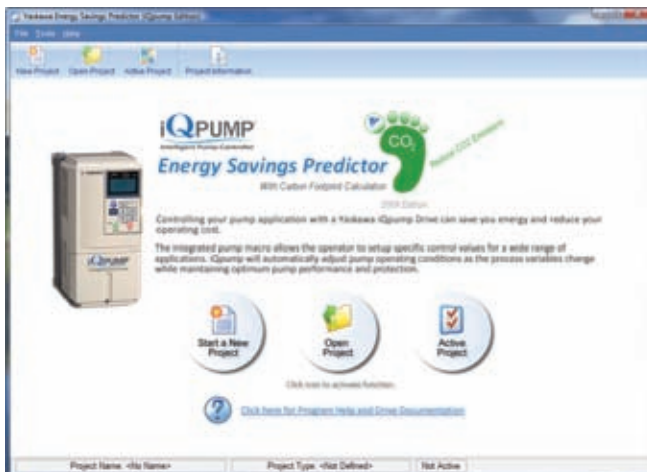

Utility Harmonics Estimator

Estimate harmonics contribution back to main power source

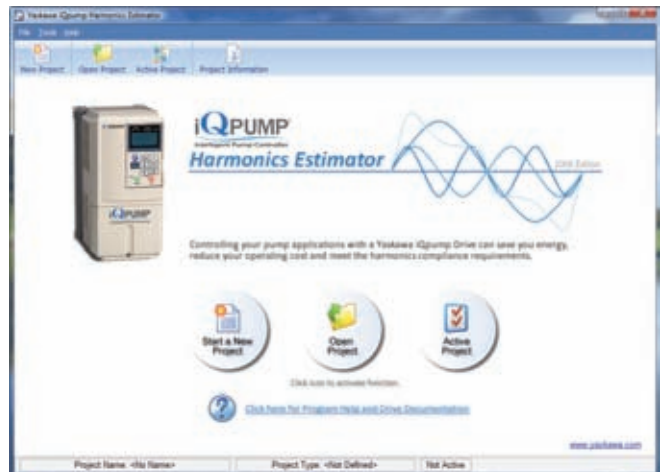



Software Features

Programmable Set Point and Scaling

12 different plain text engineering units are available, including PSI and GPM.

Control Pressure, Start Level and Start Time

Flexibility to start the pump at different feedback levels or use the integrated timer to eliminate cycling.

Sleep Mode Minimum Flow Protection

Protects and shuts down the pump at low speeds or in low flow conditions.

Sleep Boost

Intended for use with a pressure tank, iQpump will boost the set pressure prior to shutdown, extending the pump's sleep time, reducing cycling, and saving energy.

No Flow Detection

Separate from Sleep Mode, this detects changes in pump motor RPM relative to sudden changes in pressure or flow; protecting against broken pipe, excessive well drawdown or run-dry conditions.

Pre-Charge Control

This programmable feature eliminates water hammer and extends system life by gradually filling a pipeline before normal full pressure and flow operation. Pump motor speed can be controlled with a system timer, level or pressure control device to indicate when normal operation may begin.

Thrust Bearing Control

Protects the bearings of submersible pump motors by ensuring start up speeds and times meet manufacturer's recommendations.

Automatic System Restart

Programmable timers allow iQpump to automatically restart the system in Auto Mode for faults relating to brown outs, loss of power, and pump specific faults.

Utility Start Delay Timer

Used in conjunction with "Automatic Restart", a programmable timer will delay starting to allow for multiple pumps to sequence start on loss of power. This function ensures that the power system is not stressed when utility power has returned and pump system is automatically restarted.

Loss of Prime (LOP)

Loss of prime protection is a feature to protect the pump and motor from damage that would be caused if the pump were operated without water. If a pump were to lose prime and continue to operate without water moving through the pump, the pump would develop heat, which would eventually damage the pump seal, motor, pipe manifold and related components.

Low and High Pressure Feedback Detection

iQpump continuously monitors the system feedback device to provide a warning alarm or fault based on the programmed level.

Transducer Loss Protection

iQpump monitors the feedback device voltage or current levels to determine if the transducer has failed.

Flow Meter Data Logging

Through a secondary analog input a flow sensor can be connected inline with the pump system back to iQpump to read and accumulate total flow for system reporting to authorities. System can be configured to detect "No Flow" and "Sleep" on low demand.

Flow Monitor Loss Protection

iQpump monitors the current or voltage signal of the flow feedback device to determine if a failure has occurred.

Single Drive with Two Pump Alternation Sequence

This feature will sequence iQpump digital outputs based on pump run time hours to alternate two pumps for even wear.

Multiplex Automatic Stabilization

iQpump automatically balances multi-pump systems to stabilize performance and reduce cycling.

Timed Run / Stop Control

Provides a method to automatically run and stop for a given amount of time. This feature is used for clearing sediment out of newly drilled wells and tank filling control.

Impeller Anti-Jam Automatic Control

Provides a method for the user to select iQpump to detect high current and attempt to expel corrosion or solids which are keeping the pump impeller from operating efficiently, system will perform a quick reversal to try and dislodge jam.

Impeller De-Scale Automatic Control

iQpump will monitor pump run time hours and will perform a rapid bi-directional acceleration to dislodge scale.

Low City Pressure

Municipal booster systems that use an external pressure switch to monitor a minimum inlet city pressure for the pump system to run. iQpump will monitor the pressure switch and will display "Low City Pressure" to alert operator that an issue has occurred outside of the iQpump and pump system.

Lube Pump Control

Designed for pumps that require pre-lubrication before each start. Digital output will energize a solenoid valve for a programmable time before starting allowing for lubrication each time the pump is started.

Constant Pressure with Well Draw Down Control

This function allows iQpump to control constant pressure when there is adequate water in the well, while monitoring a second down hole transducer for water level. If the water level drops below user settings then iQpump reduces pump speed to maximize well output. System will return automatically to normal operation when well water is recharged to an adequate level.

Time Delayed External Fault Inputs

Programmable settings that will delay pump faults to allow for transition of input power from utility to generator and vice versa. Examples are moisture relays, seal failure relays, external phase monitors, etc.

Motor Protection

- Output Phase Loss
- Ground Fault
- Motor Overload
- Motor Over Temperature
- Broken Shaft

iQpump Controller Protection

- Over Voltage
- Input Phase Loss
- Under Voltage
- Phase Imbalance
- Short Circuit

Pump Fault and Alarms

iQpump provides a comprehensive set of pump related alarms and faults. Faults are displayed on the keypad in clear text to eliminate confusion:

- Over Cycling
- No Flow
- Loss of Prime
- Transducer Loss
- Over Torque
- Low and High Pressure Feedback Detection
- Pump Over Cycling
- Dry Well



UL Type NEMA 3R enclosures available

NEMA 12 enclosures available

Engineered Options:
Circuit Breaker | Bypass Contactors | Input/Output Line Reactor
Surge Arrestor | EMI/RFI Filter | Output dV/dt Filter
Space Heater | Fused Disconnect

Why Use Single-Phase?

UL Tested and Approved for use on Single-Phase Power

In rural areas or commercial office buildings that were not originally designed to support heavy manufacturing, utilities do not install three-phase power because the cost is significantly more than single-phase power. For many years, people have been using different technology to generate three-phase power from single-phase power sources. Common technologies include rotary-phase converters, static-phase converters and variable frequency drives. As initial investment costs of variable frequency drives have been lowered more users are turning to iQpump as the best solution to convert single-phase pump motor applications to three-phase.

Benefits of Three-Phase over Single-Phase Motors

1. Three-phase motors are more compact and less costly than a single-phase motor of the same voltage class and HP (kW) rating.
2. Single-phase AC motors above 10 HP (7.5 kW) are not as efficient and not usually manufactured in large quantity.
3. Three-phase motors have better starting torque, run more efficiently (i.e. 90% compared to 70%), and last much longer than their single-phase counterparts.
4. iQpump will provide motor protection at the same time providing for a more efficient and lower cost system.
5. Reduced motor cable sizes equal lower cost for long motor runs.

Note: When sizing iQpump for single to three-phase power conversion consult your local Yaskawa Representative.

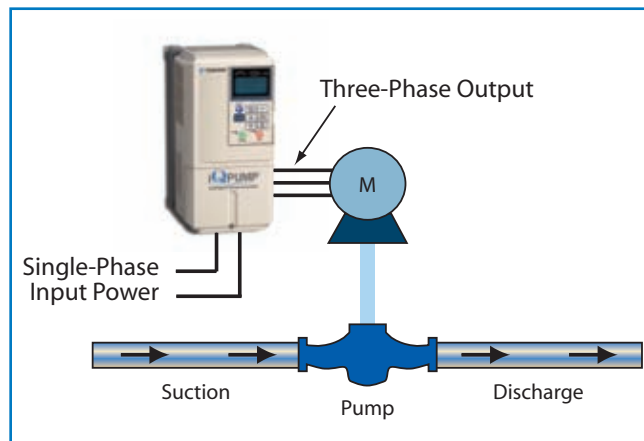

Block Diagram of Single to Three-Phase



Yaskawa Electric America, Inc.
2121 Norman Drive South
Waukegan, IL 60085

800-YASKAWA (927-5292) Fax: 847-887-7310
DrivesHelpDesk@yaskawa.com www.yaskawa.com